

# PROPOSAL ONLY

DO NOT BUILD TO THIS PLAN,  
SPECIFICATION STILL TO BE CONFIRMED

The Kew Torberry Greenhouse Range features:

1. Glass:
  - 4mm thick clear, toughened safety glass.
2. Door:
  - Opening in & Hinged on the left. Brass furniture.
3. Finish: Polyester powder coating.  
Frame colour - As stated on customer order form.  
Bench & Cold Frame colour - As stated on customer order form.
4. Materials: Aluminium extrusions with stainless steel fixings.
5. Frame: Alitex Traditional suite of extrusions, which includes the "Heavy Bar" portal frames & cast aluminium spandrel brackets.
6. Shades: - Optional.  
- Either 1 pair of tapered shades on the lobby side or rectangular shades under the roof vents.
7. Other fittings: All other fittings are available at additional cost.
8. Downpipes: If no reservoir is specified downpipes to be taken to ground with shoes.
9. Ridge decorations:
  - Finials and Fleur-de-Lys cresting fitted as standard. Ball finial option is available.
10. Ventilator actuation:
  - Roof vents are automatically operated (Bayliss passive system).
  - Side vents are manually operated.
11. Pre-drilled holes in the gable verticals and roof spans for high level shelving (shelving is available at extra cost).

Please refer to Bench & Internal Layout drawing for Reservoir position if required. If no reservoir requested then down pipes will be taken to ground. Gullies to be provided by builder as shown. These should go to surface drainage or to a soakaway.

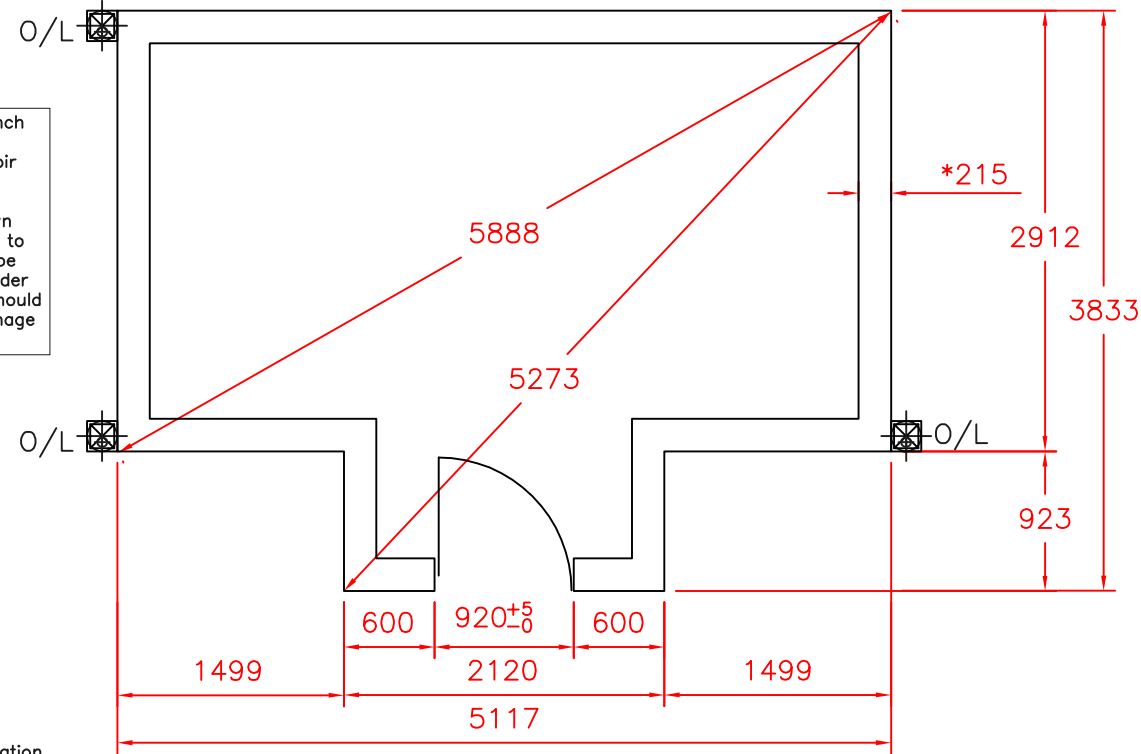
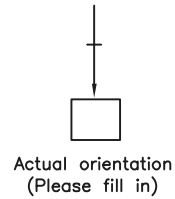

GROUND PLAN.

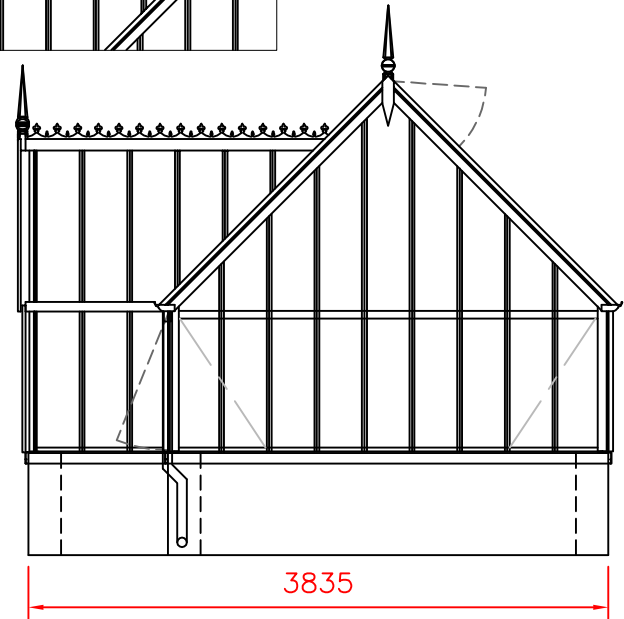
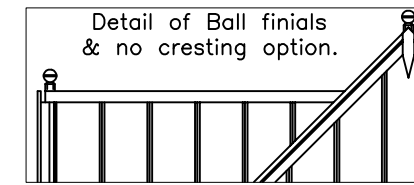

GABLE ELEVATION

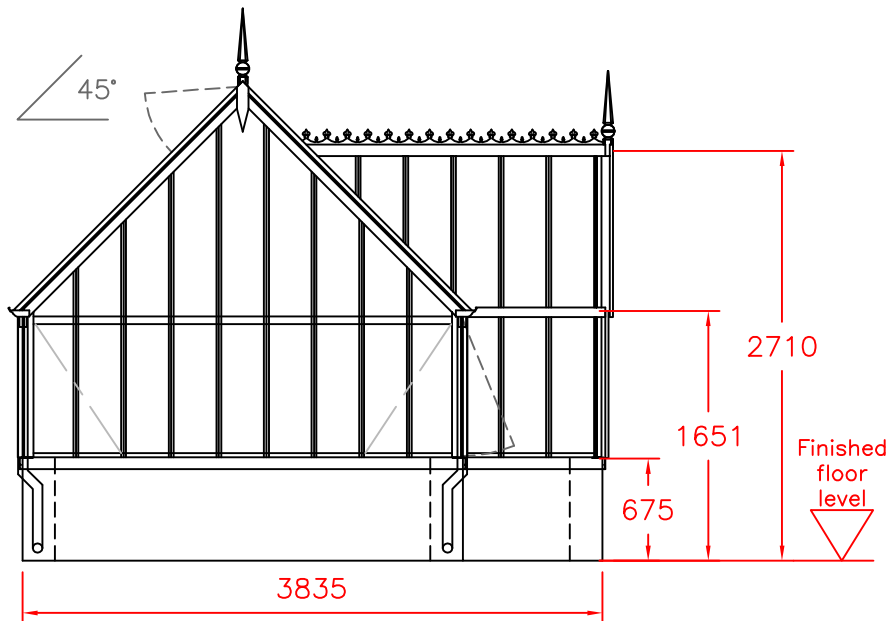

GABLE ELEVATION

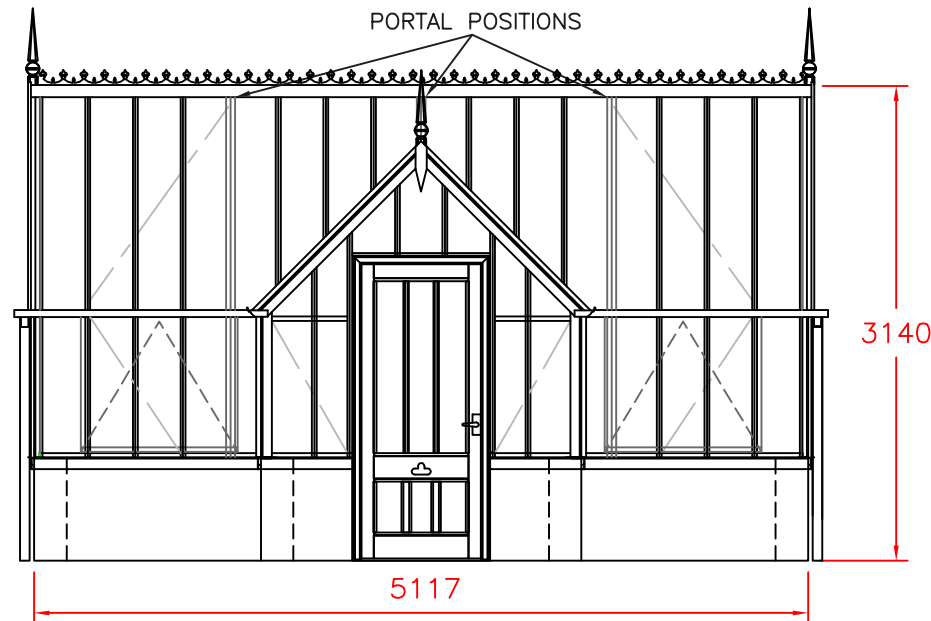

SIDE ELEVATION

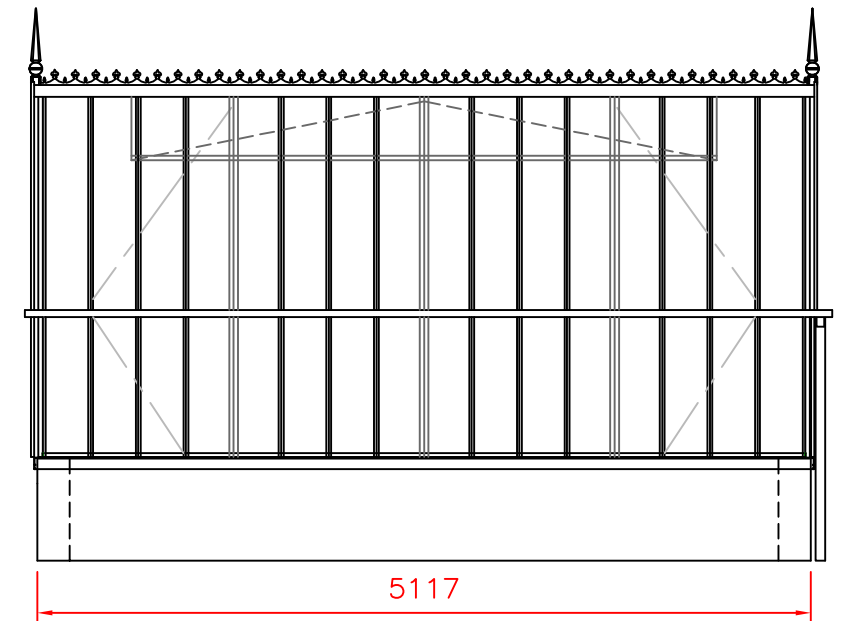

SIDE ELEVATION

O/L = GUTTER OUT-LET  
DIMENSIONS IN MILLIMETRES  
PLEASE SEE ATTACHED BUILDING NOTES.  
TOLERANCE: + OR - 5mm, EXCEPT AT DOORWAY.

- \* 215mm - Nominal dimension, wall should be Solid with header course.
- \* 102mm - Nominal dimension, single course wall Cold frames & Internal Planters Only.

The dimensions shown on this drawing are those of the required base wall. As our structures are manufactured to accommodate these dimensions the completed base MUST correspond exactly (by steel tape measure) to the measurements on this drawing. If the base wall is incorrect in any way, the expense of alterations and delays in installation etc., are the responsibility of the builder and/or the customer.

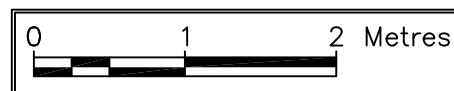

|                                    |          |   |                         |     |
|------------------------------------|----------|---|-------------------------|-----|
| <br>GREENHOUSES AND CONSERVATORIES |          | TITLE   |                         |     |
|                                    |          | KEW GREENHOUSE COLLECTION<br>THE FORTREY<br>(Greenhouse Proposal) |                         |     |
| DRAWN                              | DATE     | SCALE   | DWG NO.                 | REV |
| FMcB                               | 27.09.16 | 1:50 @A3  | Fortrey Proposal 1 of 3 |     |
| CHECKED                            | CHECKED  | CUSTOMER / ORDER No.  |                         |     |

**PROPOSAL ONLY**

DO NOT BUILD TO THIS PLAN,  
SPECIFICATION STILL TO BE CONFIRMED

- The Kew Torberry Greenhouse Range features:
1. Glass:
    - 4mm thick clear, toughened safety glass.
  2. Door:
    - Opening in & Hinged on the left. Brass furniture.
  3. Finish: Polyester powder coating.  
Frame colour - As stated on customer order form.  
Bench & Cold Frame colour - As stated on customer order form.
  4. Materials: Aluminium extrusions with stainless steel fixings.
  5. Frame: Alitex Traditional suite of extrusions, which includes the "Heavy Bar" portal frames & cast aluminium spandrel brackets.
  6. Shades: - Optional.
    - Either 1 pair of tapered shades on the lobby side or rectangular shades under the roof vents.
  7. Other fittings: All other fittings are available at additional cost.
  8. Downpipes: If no reservoir is specified downpipes to be taken to ground with shoes.
  9. Ridge decorations:
    - Finials and Fleur-de-Lys cresting fitted as standard. Ball finial option is available.
  10. Ventilator actuation:
    - Roof vents are automatically operated (Bayliss passive system).
    - Side vents are manually operated.
  11. Pre-drilled holes in the gable verticals and roof spans for high level shelving (shelving is available at extra cost).

Please refer to Bench & Internal Layout drawing for Reservoir position if required. If no reservoir requested then down pipes will be taken to ground. Gullies to be provided by builder as shown. These should go to surface drainage or to a soakaway.

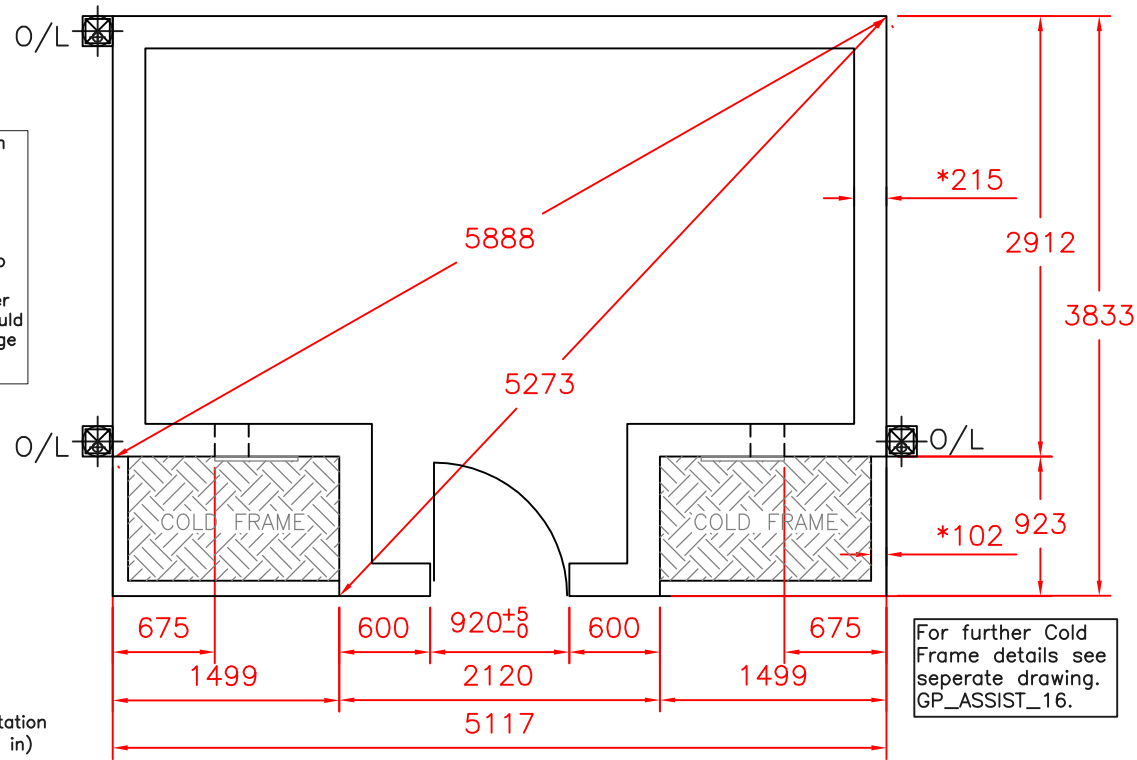
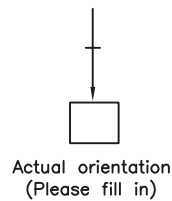

GROUND PLAN.

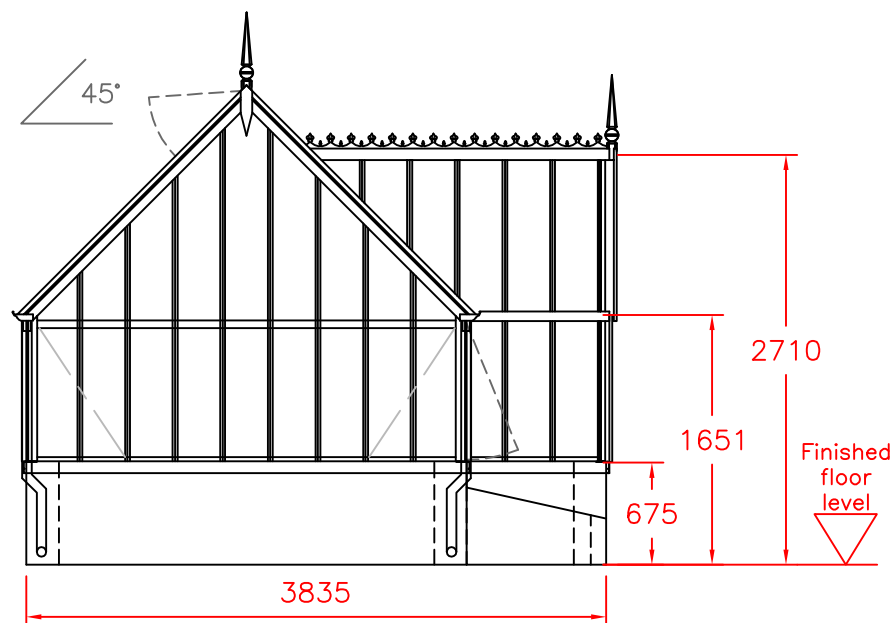
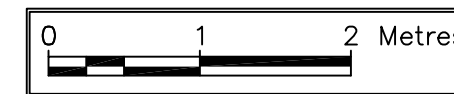

GABLE ELEVATION

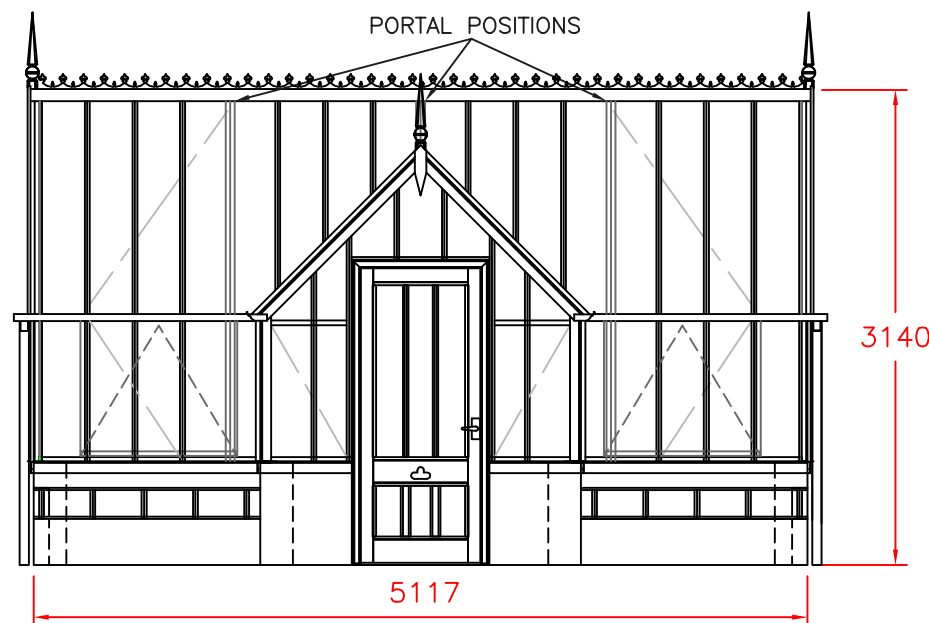

SIDE ELEVATION

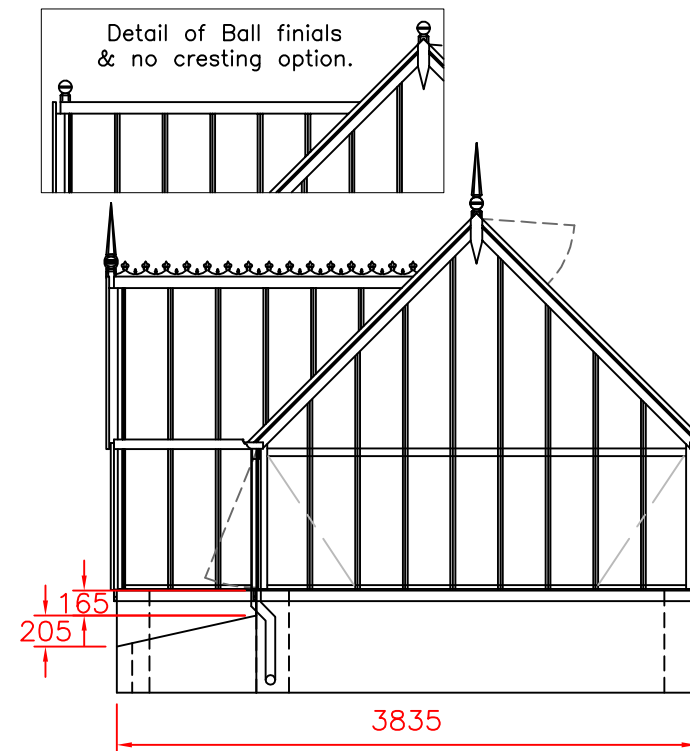

GABLE ELEVATION

O/L = GUTTER OUT-LET  
DIMENSIONS IN MILLIMETRES  
PLEASE SEE ATTACHED BUILDING NOTES.  
TOLERANCE: + OR - 5mm, EXCEPT AT DOORWAY.

- \* 215mm - Nominal dimension, wall should be Solid with header course.
- \* 102mm - Nominal dimension, single course wall Cold frames & Internal Planters Only.

The dimensions shown on this drawing are those of the required base wall. As our structures are manufactured to accommodate these dimensions the completed base MUST correspond exactly (by steel tape measure) to the measurements on this drawing. If the base wall is incorrect in any way, the expense of alterations and delays in installation etc., are the responsibility of the builder and/or the customer.



|   |          |   |                         |     |
|---|----------|---|-------------------------|-----|
| <p>ALITEX™<br/>GREENHOUSES AND CONSERVATORIES</p> |          | TITLE   |                         |     |
|   |          | KEW GREENHOUSE COLLECTION<br>THE FORTREY<br>(Greenhouse Proposal) |                         |     |
| DRAWN   | DATE     | SCALE   | DWG NO.                 | REV |
| FMcB  | 27.09.16 | 1:50 @A3  | Fortrey Proposal 2 of 3 |     |
| CHECKED   | CHECKED  | CUSTOMER / ORDER No.  |                         |     |

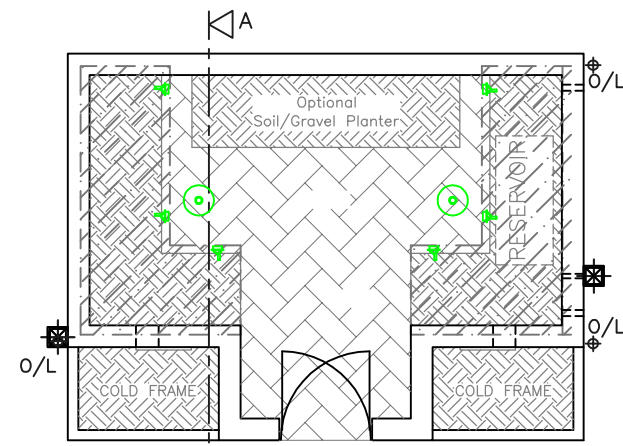
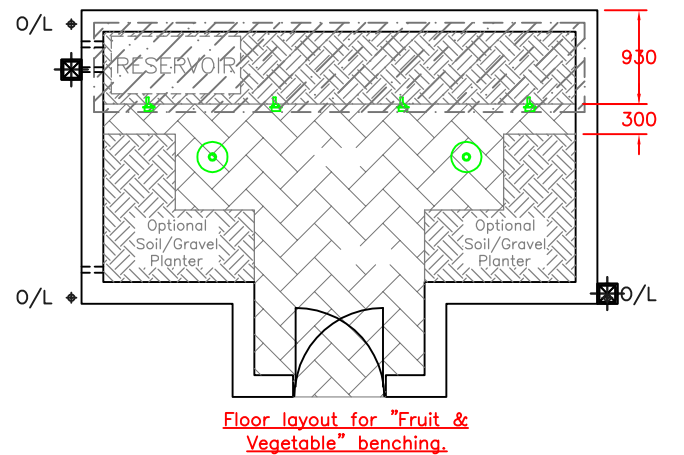
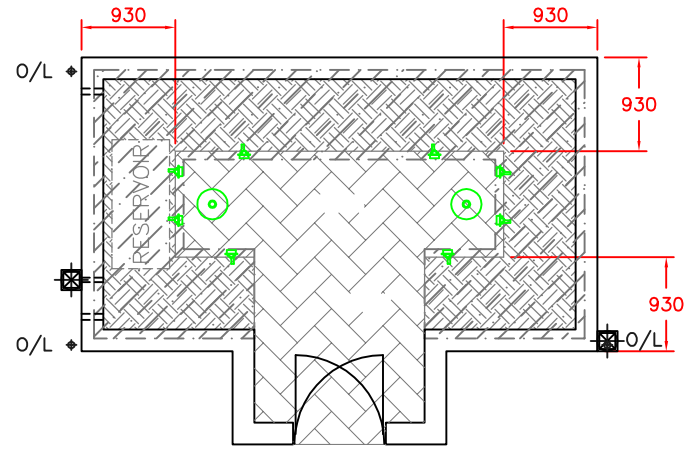
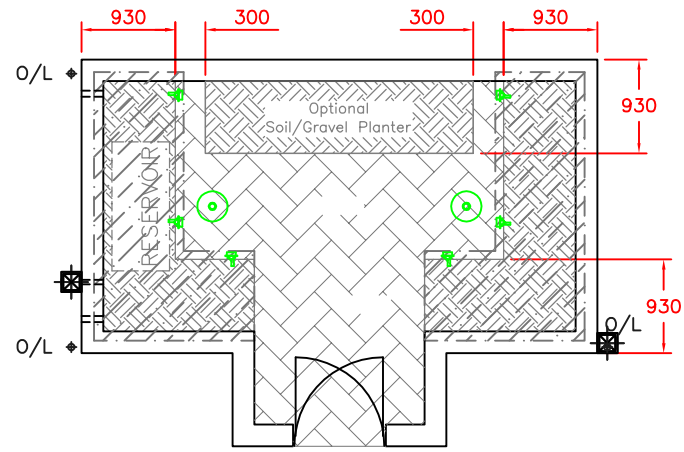
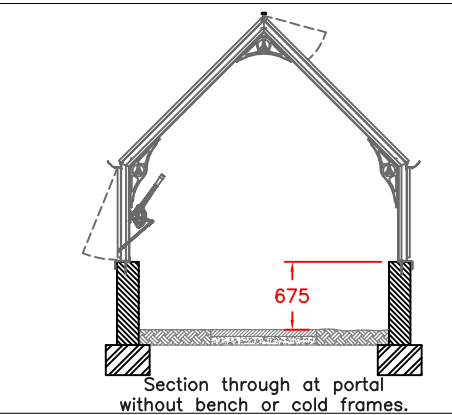
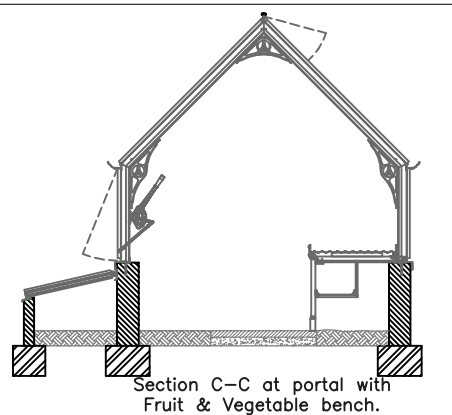
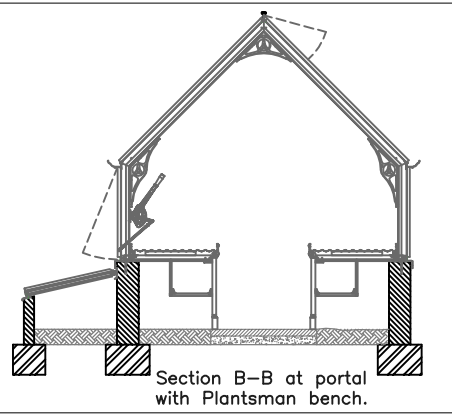
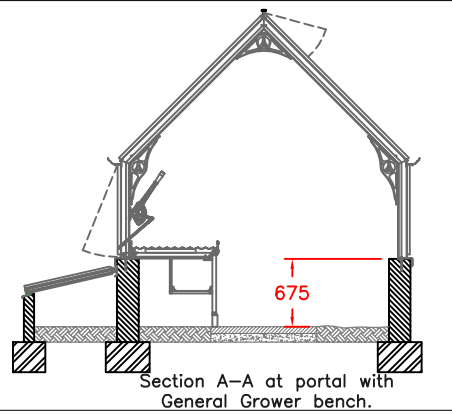

For further Cold Frame details see separate drawing. GP\_ASSIST\_16.

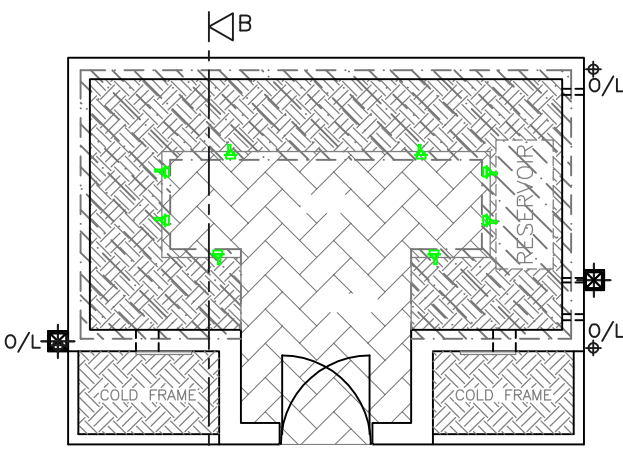

For further Cold Frame details see separate drawing. GP\_ASSIST\_16.

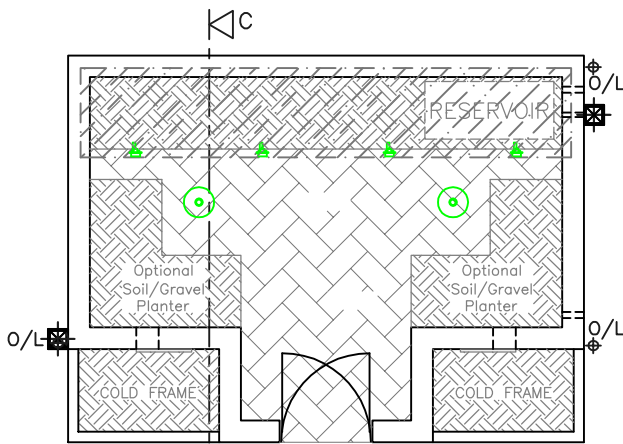

For further Cold Frame details see separate drawing. GP\_ASSIST\_16.

Product: Traditional Benching attached to greenhouse framework. Bench lower shelf will be supplied to maximum possible area (it is not continuous into corners).

\*Tick appropriate box to highlight choice.

Gravel or soil under benching for drainage

**PROPOSAL ONLY**  
DO NOT BUILD TO THIS PLAN, SPECIFICATION STILL TO BE CONFIRMED

O/L = GUTTER OUT-LET  
DIMENSIONS IN MILLIMETRES  
PLEASE SEE ATTACHED BUILDING NOTES.  
TOLERANCE: + OR - 5mm, EXCEPT AT DOORWAY.  
\* 215mm - Nominal dimension, wall should be Solid with header course.  
\* 102mm - Nominal dimension, single course wall Cold frames & Internal Planters Only.

The dimensions shown on this drawing are those of the required base wall. As our structures are manufactured to accommodate these dimensions the completed base MUST correspond exactly (by steel tape measure) to the measurements on this drawing. If the base wall is incorrect in any way, the expense of alterations and delays in installation etc., are the responsibility of the builder and/or the customer.

- DRAIN/GULLEY
- VENT MOTOR
- CONTROL PANEL
- SHADES
- PATH
- BENCHING
- GRAVEL/SOIL

|                                    |          |   |                         |     |
|------------------------------------|----------|---|-------------------------|-----|
| <br>GREENHOUSES AND CONSERVATORIES |          | TITLE   |                         |     |
|                                    |          | KEW GREENHOUSE COLLECTION<br>THE FORTREY<br>(Greenhouse Proposal) |                         |     |
| DRAWN                              | DATE     | SCALE   | DWG NO.                 | REV |
| FMcB                               | 27.09.16 | 1:50 @A3  | Fortrey Proposal 3 of 3 |     |
| CHECKED                            | CHECKED  | CUSTOMER / ORDER No.  |                         |     |